

Solid Tantalum Surface Mount Chip Capacitors, Molded Case, Ultra Flat Low Profile

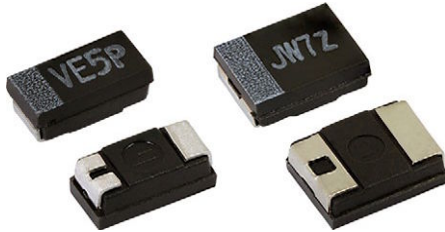

PERFORMANCE / ELECTRICAL CHARACTERISTICS

Operating Temperature: -55 °C to +125 °C
(above 85 °C, voltage derating is required)

Capacitance Range: 0.1 μF to 220 μF

Capacitance Tolerance: ± 10 %, ± 20 %

Voltage Rating: 2.5 V_{DC} to 35 V_{DC}

FEATURES

- Small size, low profile
- Terminations:
Case UA: 100 % matte tin
Case UB: Ni / Pd / Au
- Qualified to EIA-717
- MSL level: 1 (UA case size), 3 (UB case size)
- Compatible with “high volume” automatic pick and place equipment
- Material categorization: for definitions of compliance please see www.vishay.com/doc?99912



RoHS COMPLIANT

HALOGEN FREE
Available

GREEN
(5-2008)
Available

APPLICATIONS

- Industrial
- General purpose

ORDERING INFORMATION

TMCU	A	1G	107	M	TR	(2)	F
TYPE	CASE CODE	DC VOLTAGE RATING AT +85 °C	CAPACITANCE (μF)	CAPACITANCE TOLERANCE	PACKAGING POLARITY	(OPTIONAL)	TERMINAL CODE
	See Ratings and Case Codes table.	0E = 2.5 V 0G = 4 V 0J = 6.3 V (7 V) 1A = 10 V 1C = 16 V 1D = 20 V 1E = 25 V 1V = 35 V	This is expressed in picofarads. The first two digits are the significant figures. The third is the number of zeros to follow.	K = ± 10 % M = ± 20 %	TR = 7" reel, cathodes close to perforation side	Halogen-free (special order)	F = lead (Pb)-free terminations

DIMENSIONS in inches [millimeters]

CASE CODE	EIA SIZE	L	W	H	l	a
UA	3216-12	0.126 ± 0.008 [3.2 ± 0.2]	0.063 ± 0.008 [1.6 ± 0.2]	0.047 max. [1.2 max.]	0.030 ± 0.012 [0.8 ± 0.3]	0.047 ± 0.008 [1.2 ± 0.2]
UB	3528-12	0.138 ± 0.008 [3.5 ± 0.2]	0.110 ± 0.008 [2.8 ± 0.2]	0.047 max. [1.2 max.]	0.030 ± 0.012 [0.8 ± 0.3]	0.071 ± 0.008 [1.8 ± 0.2]

RATINGS AND CASE CODES								
μF	2.5 V	4 V	6.3 V (7 V)	10 V	16 V	20 V	25 V	35 V
0.10								UA
0.15								UA
0.22								UA
0.33							UA	
0.47							UA	
0.68						UA	UA	
1.0						UA / UB	UA	UA / UB
1.5					UA	UA / UB	UB	UB
2.2					UA / UB	UA / UB	UB	UB
3.3					UA / UB	UA / UB	UB	
4.7				UA	UA / UB	UA / UB	UB	
6.8				UA	UA / UB	UB		
10			UA	UA	UA / UB			
15	UA	UA	UA	UA / UB	UB			
22	UA	UA	UA / UB	UA / UB	UB			
33	UA / UB	UA / UB	UA / UB	UB				
47	UA / UB	UA / UB	UA / UB	UB				
68	UB	UB	UB					
100	UB	UB	UB					
150	UB	UB						
220	UB	UB						

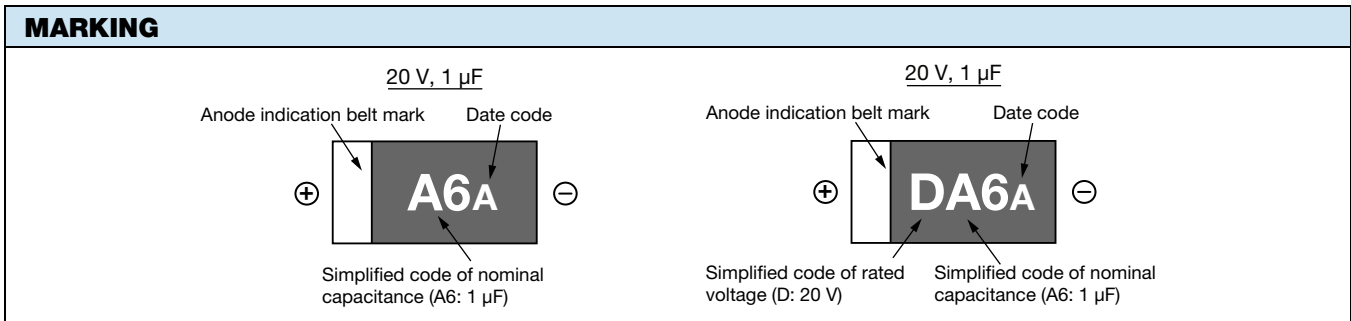

CAPACITANCE AND VOLTAGE MARKING								
μF	2.5 V	4 V	6.3 V	10 V	16 V	20 V	25 V	35 V
0.10								VA5
0.15								VE5
0.22								VJ5
0.33							EN5	
0.47							ES5	
0.68						DW5	EW5	
1.0						DA6 ⁽¹⁾ A6 ⁽²⁾	EA6	VA6
1.5					CE6	DE6 ⁽¹⁾ E6 ⁽²⁾	EE6	VE6
2.2					CJ6 ⁽¹⁾ J6 ⁽²⁾	DJ6	EJ6	VJ6
3.3					CN6	DN6	EN6	
4.7				AS6	CS6	DS6	ES6	
6.8				AW6	CW6	DW6		
10			JA7	AA7	CA7			
15	eE7	GE7	JE7	AE7	CE7			
22	eJ7	GJ7	JJ7	AJ7	CJ7			
33	eN7	GN7	JN7	AN7				
47	eS7	GS7	JS7	AS7				
68	eW7	GW7	JW7					
100	eA8	GA8	JA8					
150	eE8	GE8						
220	eJ8	GJ8						

Notes

- (1) Marking on UA case
 (2) Marking on UB case



DATE CODE												
YEAR	MONTH											
	1	2	3	4	5	6	7	8	9	10	11	12
2017	A	B	C	D	E	F	G	H	J	K	L	M
2018	N	P	Q	R	S	T	U	V	W	X	Y	Z
2019	a	b	c	d	e	f	g	h	j	k	l	m
2020	n	p	q	r	s	t	u	v	w	x	y	z
2021	A	B	C	D	E	F	G	H	J	K	L	M
2022	N	P	Q	R	S	T	U	V	W	X	Y	Z
2023	a	b	c	d	e	f	g	h	j	k	l	m
2024	n	p	q	r	s	t	u	v	w	x	y	z

Note

- Marking code repeats every four years in alphabetical order (letter of I, i, O, and o are excluded)

STANDARD RATINGS						
CAPACITANCE (μ F)	CASE CODE	PART NUMBER	MAX. DCL AT +25 °C (μ A)	MAX. DF AT +25 °C, 120 Hz (%)	MAX. ESR AT +25 °C, 100 kHz (Ω)	MAX. RIPPLE, 100 kHz I _{RMS} (A)
2.5 V_{DC} AT +85 °C; 1.6 V_{DC} AT +125 °C						
15	UA	TMCUA0E156(1)TRF	0.5	8	3.0	0.161
22	UA	TMCUA0E226(1)TRF	0.6	8	1.8	0.208
33	UA	TMCUA0E336(1)TRF	1.7	12	1.8	0.208
33	UB	TMCUB0E336(1)TRF	0.8	12	1.7	0.238
47	UA	TMCUA0E476(1)TRF	2.4	18	1.8	0.208
47	UB	TMCUB0E476(1)TRF	1.2	12	1.7	0.238
68	UB	TMCUB0E686(1)TRF	1.7	15	1.7	0.238
100	UB	TMCUB0E107(1)TRF	5.0	20	1.1	0.295
150	UB	TMCUB0E157(1)TRF	7.5	30	1.1	0.295
220	UB	TMCUB0E227(1)TRF	11.0	30	1.1	0.295
4 V_{DC} AT +85 °C; 2.5 V_{DC} AT +125 °C						
15	UA	TMCUA0G156(1)TRF	0.6	8	3.0	0.161
22	UA	TMCUA0G226(1)TRF	0.9	8	1.8	0.208
33	UA	TMCUA0G336(1)TRF	2.6	12	1.8	0.208
33	UB	TMCUB0G336(1)TRF	1.3	12	1.7	0.238
47	UA	TMCUA0G476(1)TRF	3.8	18	1.8	0.208
47	UB	TMCUB0G476(1)TRF	1.9	12	1.7	0.238
68	UB	TMCUB0G686(1)TRF	2.7	15	1.7	0.238
100	UB	TMCUB0G107(1)TRF	8.0	20	1.1	0.295
150	UB	TMCUB0G157(1)TRF	12.0	30	1.1	0.295
220	UB	TMCUB0G227MTRF	17.6	30	1.1	0.295
6.3 V_{DC} (7 V_{DC}) AT +85 °C; 4 V_{DC} AT +125 °C						
10	UA	TMCUA0J106(1)TRF	0.7	8	4.0	0.140
15	UA	TMCUA0J156(1)TRF	1.1	8	2.9	0.164
22	UA	TMCUA0J226(1)TRF	2.8	12	2.9	0.164
22	UB	TMCUB0J226(1)TRF	1.4	10	1.7	0.238
33	UA	TMCUA0J336(1)TRF	4.2	20	2.9	0.164
33	UB	TMCUB0J336(1)TRF	2.3	10	1.7	0.238
47	UA	TMCUA0J476MTRF	5.9	20	2.9	0.164
47	UB	TMCUB0J476(1)TRF	3.3	12	1.7	0.238
68	UB	TMCUB0J686(1)TRF	8.6	20	1.7	0.238
100	UB	TMCUB0J107MTRF	12.6	20	1.1	0.295

Notes

- Part number definition:
(1) Tolerance: For 10 % tolerance, specify "K"; for 20 % tolerance, change to "M"
- Termination code "F":
Case UA: 100 % tin; case UB: Ni / Pd / Au



STANDARD RATINGS						
CAPACITANCE (μ F)	CASE CODE	PART NUMBER	MAX. DCL AT +25 °C (μ A)	MAX. DF AT +25 °C, 120 Hz (%)	MAX. ESR AT +25 °C, 100 kHz (Ω)	MAX. RIPPLE, 100 kHz I _{RMS} (A)
10 V_{DC} AT +85 °C; 6.3 V_{DC} AT +125 °C						
4.7	UA	TMCUA1A475(1)TRF	0.5	6	4.0	0.140
6.8	UA	TMCUA1A685(1)TRF	0.7	6	4.0	0.140
10	UA	TMCUA1A106(1)TRF	1.0	8	4.0	0.140
15	UA	TMCUA1A156(1)TRF	3.0	12	2.9	0.164
15	UB	TMCUB1A156(1)TRF	1.5	10	2.8	0.185
22	UA	TMCUA1A226MTRF	4.4	18	2.9	0.164
22	UB	TMCUB1A226(1)TRF	2.2	10	1.7	0.238
33	UB	TMCUB1A336(1)TRF	6.6	12	1.7	0.238
47	UB	TMCUB1A476MTRF	9.4	30	1.7	0.238
16 V_{DC} AT +85 °C; 10 V_{DC} AT +125 °C						
1.5	UA	TMCUA1C155(1)TRF	0.5	6	8.8	0.094
2.2	UA	TMCUA1C225(1)TRF	0.5	6	7.7	0.101
2.2	UB	TMCUB1C225(1)TRF	0.5	6	6.6	0.121
3.3	UA	TMCUA1C335(1)TRF	0.5	6	7.7	0.101
3.3	UB	TMCUB1C335(1)TRF	0.5	6	4.0	0.155
4.7	UA	TMCUA1C475(1)TRF	0.8	8	4.0	0.140
4.7	UB	TMCUB1C475(1)TRF	0.8	6	4.0	0.155
6.8	UA	TMCUA1C685(1)TRF	1.1	12	4.0	0.140
6.8	UB	TMCUB1C685(1)TRF	1.1	6	4.0	0.155
10	UA	TMCUA1C106MTRF	1.6	18	3.3	0.154
10	UB	TMCUB1C106(1)TRF	1.6	8	2.8	0.185
15	UB	TMCUB1C156(1)TRF	4.8	12	2.8	0.185
22	UB	TMCUB1C226MTRF	7.0	18	1.7	0.238
20 V_{DC} AT +85 °C; 13 V_{DC} AT +125 °C						
0.68	UA	TMCUA1D684(1)TRF	0.5	4	19.8	0.063
1.0	UA	TMCUA1D105(1)TRF	0.5	4	16.5	0.069
1.0	UB	TMCUB1D105(1)TRF	0.5	4	8.8	0.104
1.5	UA	TMCUA1D155(1)TRF	0.5	6	16.5	0.069
1.5	UB	TMCUB1D155(1)TRF	0.5	6	8.8	0.104
2.2	UA	TMCUA1D225(1)TRF	0.5	6	7.7	0.101
2.2	UB	TMCUB1D225(1)TRF	0.5	6	6.6	0.121
3.3	UA	TMCUA1D335MTRF	0.7	6	7.7	0.101
3.3	UB	TMCUB1D335(1)TRF	0.7	6	4.0	0.155
4.7	UA	TMCUA1D475MTRF	0.9	8	4.0	0.140
4.7	UB	TMCUB1D475(1)TRF	0.9	6	4.0	0.155
6.8	UB	TMCUB1D685MTRF	1.4	6	2.8	0.185
25 V_{DC} AT +85 °C; 16 V_{DC} AT +125 °C						
0.33	UA	TMCUA1E334(1)TRF	0.5	4	26.4	0.054
0.47	UA	TMCUA1E474(1)TRF	0.5	4	22.0	0.060
0.68	UA	TMCUA1E684(1)TRF	0.5	8	19.8	0.063
1.0	UA	TMCUA1E105(1)TRF	0.5	8	16.5	0.069
1.5	UB	TMCUB1E155(1)TRF	0.5	6	8.8	0.104
2.2	UB	TMCUB1E225(1)TRF	0.6	6	6.6	0.121
3.3	UB	TMCUB1E335(1)TRF	0.8	6	4.0	0.155
4.7	UB	TMCUB1E475MTRF	1.2	6	4.0	0.155

Notes

- Part number definition:
(1) Tolerance: For 10 % tolerance, specify "K"; for 20 % tolerance, change to "M"
- Termination code "F":
Case UA: 100 % tin; case UB: Ni / Pd / Au



STANDARD RATINGS						
CAPACITANCE (μ F)	CASE CODE	PART NUMBER	MAX. DCL AT +25 °C (μ A)	MAX. DF AT +25 °C, 120 Hz (%)	MAX. ESR AT +25 °C, 100 kHz (Ω)	MAX. RIPPLE, 100 kHz I _{RMS} (A)
35 V _{DC} AT +85 °C; 22 V _{DC} AT +125 °C						
0.10	UA	TMCUA1V104(1)TRF	0.5	4	40.0	0.044
0.15	UA	TMCUA1V154(1)TRF	0.5	4	40.0	0.044
0.22	UA	TMCUA1V224(1)TRF	0.5	4	40.0	0.044
1.0	UA	TMCUA1V105MTRF	0.5	8	16.5	0.069
1.0	UB	TMCUB1V105(1)TRF	0.5	6	8.8	0.104
1.5	UB	TMCUB1V155(1)TRF	0.5	6	8.8	0.104
2.2	UB	TMCUB1V225MTRF	0.8	6	6.6	0.121

Notes

- Part number definition:
(1) Tolerance: For 10 % tolerance, specify "K"; for 20 % tolerance, change to "M"
- Termination code "F":
Case UA: 100 % tin; case UB: Ni / Pd / Au

RECOMMENDED VOLTAGE DERATING GUIDELINES (for temperature below +85 °C)	
CAPACITOR VOLTAGE RATING	OPERATING VOLTAGE
2.5	1.2
4.0	2.0
6.3 (7.0)	3.1 (3.5)
10	5.0
16	8.0
20	10.0
25	12.5
35	17.5

Note

- For more information about recommended voltage derating see technical note www.vishay.com/doc?40246

POWER DISSIPATION	
CASE CODE	MAXIMUM PERMISSIBLE POWER DISSIPATION AT +25 °C (W) IN FREE AIR
UA	0.078
UB	0.096

STANDARD PACKAGING QUANTITY	
CASE CODE	UNITS PER 7" REEL
UA	3000
UB	3000



PERFORMANCE CHARACTERISTICS						
ITEM	CONDITION	POST TEST PERFORMANCE				
			Specified initial value	-55 °C	+85 °C	+125 °C
Temperature characteristics	Measure the specified characteristics in each stage	Capacitance change	-	-12 % to 0 %	0 % to 10 %	0 % to 12 %
		Dissipation factor (%), maximum	4	5	4	5
			6	8	6	6
			8	12	10	12
			10	14	12	14
			12	16	14	16
			18	34	20	22
			20	38	22	24
		30	60	30	40	
Leakage current	Refer to Standard Ratings table	-	1000 % specified initial value or less	1250 % specified initial value or less		
Solder heat resistance	Solder Dip 260 °C ± 5 °C, 10 s ± 1 s Reflow 260 °C, 10 s ± 1 s	Capacitance change	Within ± 5 % of initial value			
		Dissipation factor	Initial specified value or less			
		Leakage current	Initial specified value or less			
Moisture resistance no load	Leave at 40 °C and 90 % to 95 % RH for 500 h	Capacitance change	Within ± 10 % of initial value			
		Dissipation factor	Initial specified value or less			
		Leakage current	Initial specified value or less			
High temperature load	85 °C. The rated voltage is applied for 2000 h	Capacitance change	Within ± 10 % of initial value			
		Dissipation factor	Initial specified value or less			
		Leakage current	Shall not exceed 125 % of initial specified value			
Thermal shock	Leave at -55 °C, normal temperature, 125 °C, and normal temperature for 30 min., 3 min, 30 min, and 3 min. Repeat this operation 5 times running.	Capacitance change	Within ± 5 % of initial value			
		Dissipation factor	Initial specified value or less			
		Leakage current	Initial specified value or less			
Moisture resistance load	Leave at 40 °C and 90 % to 95 % RH. The rated voltage applied for 500 h	Capacitance change	Within ± 10 % of initial value			
		Dissipation factor	Shall not exceed 150 % of initial specified value			
		Leakage current	Shall not exceed 200 % of initial specified value			
Failure rate	85 °C. The rated voltage is applied through a protective resistor of 1 Ω/V.	1 % / 1000 h				

Note

- Test conditions per JIS C5101-1



Guide for Tantalum Solid Electrolyte Chip Capacitors

INTRODUCTION

Tantalum electrolytic capacitors are the preferred choice in applications where volumetric efficiency, stable electrical parameters, high reliability, and long service life are primary considerations. The stability and resistance to elevated temperatures of the tantalum / tantalum oxide / manganese dioxide system make solid tantalum capacitors an appropriate choice for today's surface mount assembly technology.

Vishay Sprague has been a pioneer and leader in this field, producing a large variety of tantalum capacitor types for consumer, industrial, automotive, military, and aerospace electronic applications.

Tantalum is not found in its pure state. Rather, it is commonly found in a number of oxide minerals, often in combination with Columbium ore. This combination is known as "tantalite" when its contents are more than one-half tantalum. Important sources of tantalite include Australia, Brazil, Canada, China, and several African countries. Synthetic tantalite concentrates produced from tin slags in Thailand, Malaysia, and Brazil are also a significant raw material for tantalum production.

Electronic applications, and particularly capacitors, consume the largest share of world tantalum production. Other important applications for tantalum include cutting tools (tantalum carbide), high temperature super alloys, chemical processing equipment, medical implants, and military ordnance.

Vishay Sprague is a major user of tantalum materials in the form of powder and wire for capacitor elements and rod and sheet for high temperature vacuum processing.

THE BASICS OF TANTALUM CAPACITORS

Most metals form crystalline oxides which are non-protecting, such as rust on iron or black oxide on copper. A few metals form dense, stable, tightly adhering, electrically insulating oxides. These are the so-called "valve" metals and include titanium, zirconium, niobium, tantalum, hafnium, and aluminum. Only a few of these permit the accurate control of oxide thickness by electrochemical means. Of these, the most valuable for the electronics industry are aluminum and tantalum.

Capacitors are basic to all kinds of electrical equipment, from radios and television sets to missile controls and automobile ignitions. Their function is to store an electrical charge for later use.

Capacitors consist of two conducting surfaces, usually metal plates, whose function is to conduct electricity. They are separated by an insulating material or dielectric. The dielectric used in all tantalum electrolytic capacitors is tantalum pentoxide.

Tantalum pentoxide compound possesses high-dielectric strength and a high-dielectric constant. As capacitors are being manufactured, a film of tantalum pentoxide is applied to their electrodes by means of an electrolytic process. The film is applied in various thicknesses and at various voltages and although transparent to begin with, it takes on different colors as light refracts through it. This coloring occurs on the tantalum electrodes of all types of tantalum capacitors.

Rating for rating, tantalum capacitors tend to have as much as three times better capacitance / volume efficiency than aluminum electrolytic capacitors. An approximation of the capacitance / volume efficiency of other types of capacitors may be inferred from the following table, which shows the dielectric constant ranges of the various materials used in each type. Note that tantalum pentoxide has a dielectric constant of 26, some three times greater than that of aluminum oxide. This, in addition to the fact that extremely thin films can be deposited during the electrolytic process mentioned earlier, makes the tantalum capacitor extremely efficient with respect to the number of microfarads available per unit volume. The capacitance of any capacitor is determined by the surface area of the two conducting plates, the distance between the plates, and the dielectric constant of the insulating material between the plates.

COMPARISON OF CAPACITOR DIELECTRIC CONSTANTS	
DIELECTRIC	ϵ DIELECTRIC CONSTANT
Air or vacuum	1.0
Paper	2.0 to 6.0
Plastic	2.1 to 6.0
Mineral oil	2.2 to 2.3
Silicone oil	2.7 to 2.8
Quartz	3.8 to 4.4
Glass	4.8 to 8.0
Porcelain	5.1 to 5.9
Mica	5.4 to 8.7
Aluminum oxide	8.4
Tantalum pentoxide	26
Ceramic	12 to 400K

In the tantalum electrolytic capacitor, the distance between the plates is very small since it is only the thickness of the tantalum pentoxide film. As the dielectric constant of the tantalum pentoxide is high, the capacitance of a tantalum capacitor is high if the area of the plates is large:

$$C = \frac{\epsilon A}{t}$$

where

C = capacitance

ϵ = dielectric constant

A = surface area of the dielectric

t = thickness of the dielectric

Tantalum capacitors contain either liquid or solid electrolytes. In solid electrolyte capacitors, a dry material (manganese dioxide) forms the cathode plate. A tantalum lead is embedded in or welded to the pellet, which is in turn connected to a termination or lead wire. The drawings show the construction details of the surface mount types of tantalum capacitors shown in this catalog.

SOLID ELECTROLYTE TANTALUM CAPACITORS

Solid electrolyte capacitors contain manganese dioxide, which is formed on the tantalum pentoxide dielectric layer by impregnating the pellet with a solution of manganous nitrate. The pellet is then heated in an oven, and the manganous nitrate is converted to manganese dioxide.

The pellet is next coated with graphite, followed by a layer of metallic silver, which provides a conductive surface between the pellet and the leadframe.

Molded chip tantalum capacitor encases the element in plastic resins, such as epoxy materials. After assembly, the capacitors are tested and inspected to ensure long life and reliability. It offers excellent reliability and high stability for consumer and commercial electronics with the added feature of low cost.

Surface mount designs of "Solid Tantalum" capacitors use lead frames as shown in the accompanying drawings.

TANTALUM CAPACITORS FOR ALL DESIGN CONSIDERATIONS

Solid electrolyte designs are the least expensive for a given rating and are used in many applications where their very small size for a given unit of capacitance is of importance. Also important are their good low temperature performance characteristics and freedom from corrosive electrolytes.

Datasheets covering the various types and styles of capacitors for consumer and entertainment electronics and industry applications are available where detailed performance characteristics must be specified.

MOLDED CHIP CAPACITOR, ALL TYPES EXCEPT TMCTX / TMCJ

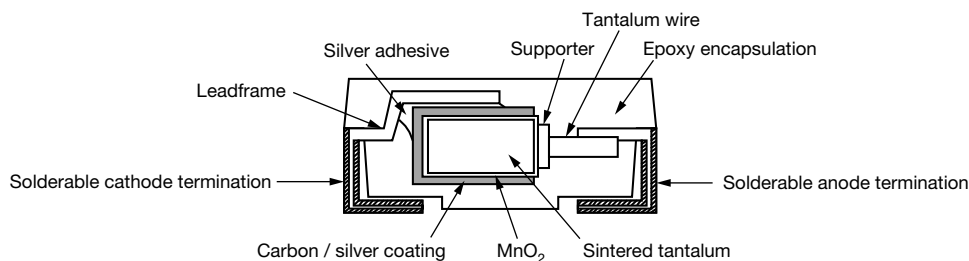

MOLDED CHIP CAPACITOR WITH BUILT-IN FUSE, TYPE TMCTX

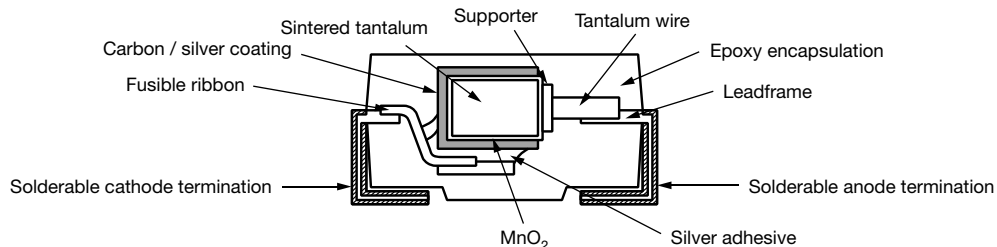

MOLDED CHIP CAPACITOR 0603 SIZE, TYPE TMCJ

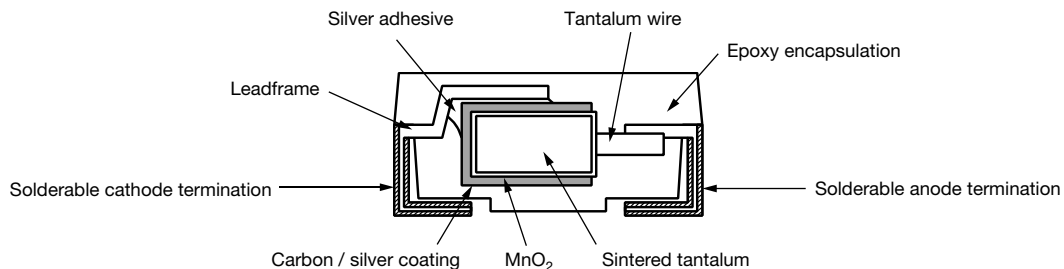

SOLID TANTALUM CAPACITORS - MOLDED CASE						
SERIES	TMCS	TMCM	TMCR	TMCU	TMCP	TMCJ
PRODUCT IMAGE						
TYPE	Solid tantalum surface mount chip capacitors, molded case					
FEATURES	Standard industrial grade	Standard industrial grade extended range	Low ESR	Low profile	0805 size	0603 size
TEMPERATURE RANGE	-55 °C to +125 °C					
CAPACITANCE RANGE	0.1 µF to 68 µF	0.47 µF to 470 µF	10 µF to 330 µF	0.1 µF to 220 µF	0.1 µF to 47 µF	0.68 µF to 22 µF
VOLTAGE RANGE	4 V to 35 V	2.5 V to 35 V	7 V to 35 V	2.5 V to 35 V	2.5 V to 25 V	2.5 V to 20 V
CAPACITANCE TOLERANCE	± 10 %, ± 20 %					± 20 %
LEAKAGE CURRENT	0.01 CV or 0.5 µA, whichever is greater					
DISSIPATION FACTOR	4 % to 6 %	4 % to 30 %	6 % to 30 %	4 % to 30 %	6 % to 30 %	20 %
CASE SIZES	A, B, C, E	A, B, C, E	B, C, E	UA, UB	P	J
TERMINATION FINISH	100 % tin			Case UA: 100 % tin Case UB: Ni / Pd / Au	100 % tin	

SOLID TANTALUM CAPACITORS - MOLDED CASE			
SERIES	TMCTX	TMCH	THC
PRODUCT IMAGE			
TYPE	Solid tantalum surface mount chip capacitors, molded case		
FEATURES	Built-in fuse	High reliability	High reliability, high temperature +150 °C
TEMPERATURE RANGE	-55 °C to +125 °C		-55 °C to +150 °C
CAPACITANCE RANGE	1.0 µF to 68 µF	0.1 µF to 100 µF	0.33 µF to 47 µF
VOLTAGE RANGE	10 V to 35 V	4 V to 35 V	10 V to 35 V
CAPACITANCE TOLERANCE	± 10 %, ± 20 %		
LEAKAGE CURRENT	0.01 CV or 0.5 µA, whichever is greater	0.005 CV or 0.25 µA, whichever is greater	
DISSIPATION FACTOR	4 % to 6 %	4 % to 8 %	4 % to 6 %
CASE SIZES	B, C, E, F	A, B, C, E, P	A, B, C, E
TERMINATION FINISH	100 % tin		

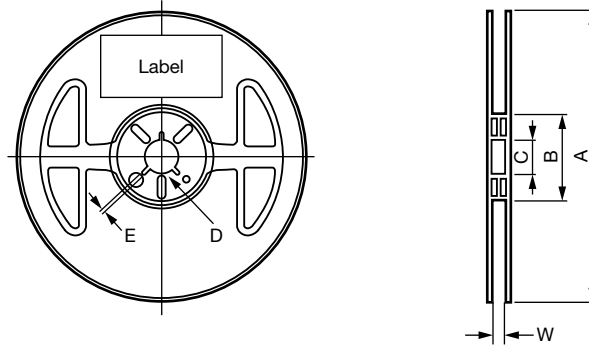
PLASTIC TAPE AND REEL PACKAGING DIMENSIONS in millimeters

CASE CODE	J, P, A, UA, B, UB	C, E, F
TAPE WIDTH	8	12
A + 0 / - 3		Ø 180
B + 1 / 0		Ø 60
C ± 0.2		Ø 13
D ± 0.5		Ø 21
E ± 0.5		2.0
W ± 0.3	9.0	13.0

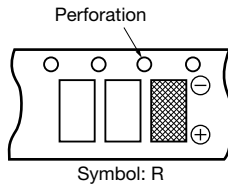
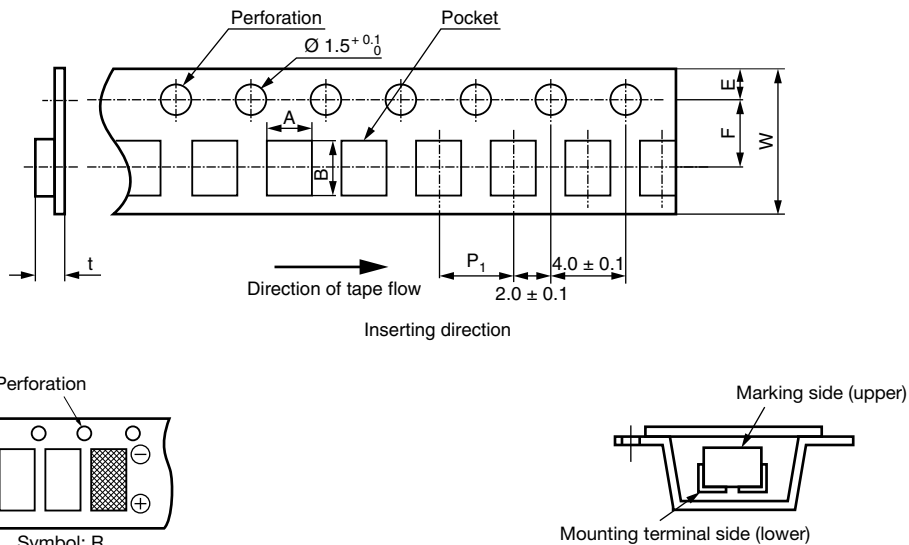
TAPE SIZE in millimeters

CASE CODE	A ± 0.2	B ± 0.2	W ± 0.3	F ± 0.1	E ± 0.1	P ₁ ± 0.1	t _{max.}
J	1.0	1.8	8.0	3.5	1.75	4.0	1.3
P	1.4	2.2	8.0	3.5	1.75	4.0	1.6
A	1.9	3.5	8.0	3.5	1.75	4.0	2.5
UA	1.9	3.5	8.0	3.5	1.75	4.0	1.7
B	3.1	3.8	8.0	3.5	1.75	4.0	2.5
UB	3.1	3.8	8.0	3.5	1.75	4.0	1.7
C	3.7	6.3	12.0	5.5	1.75	8.0	3.1
E	4.8	7.7	12.0	5.5	1.75	8.0	3.4
F	6.2	7.5	12.0	5.5	1.75	8.0	4.1

RECOMMENDED REFLOW PROFILES

Capacitors should withstand reflow profile as per J-STD-020 standard

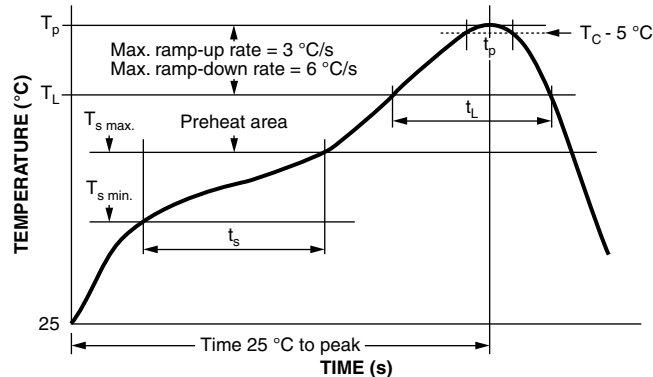

PROFILE FEATURE	LEAD (Pb)-FREE ASSEMBLY
Preheat / soak	
Temperature min. ($T_{s \text{ min.}}$)	130 °C
Temperature max. ($T_{s \text{ max.}}$)	160 °C
Time (t_s) from ($T_{s \text{ min.}}$ to $T_{s \text{ max.}}$)	60 s to 120 s
Ramp-up	
Ramp-up rate (T_L to T_p)	3 °C/s max.
Liquidus temperature (T_L)	200 °C
Time (t_L) maintained above T_L	50 s max.
Peak package body temperature (T_p) max.	Depends on case size - see table below
Time (t_p) within 5 °C of the peak maximum temperature	10 s max.
Ramp-down rate (T_p to T_L)	6 °C/s max.
Time from 25 °C to peak temperature	8 min max.

PEAK PACKAGE BODY TEMPERATURE (T_p)

CASE CODE	PEAK PACKAGE BODY TEMPERATURE (T_p)
	LEAD (Pb)-FREE PROCESS
J, P, UA, A, UB, B, C	260 °C
E, F	250 °C

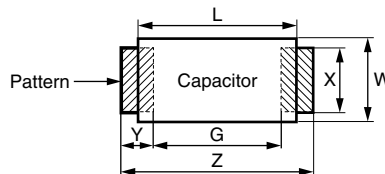
PAD DIMENSIONS in millimeters

CASE / DIMENSIONS	CAPACITOR SIZE		PAD DIMENSIONS			
	L	W	G (max.)	Z (min.)	X (min.)	Y (Ref.)
J	1.6	0.8	0.7	2.5	1.0	0.9
P	2.0	1.25	0.5	2.6	1.2	1.05
UA, A	3.2	1.6	1.1	3.8	1.5	1.35
UB, B	3.5	2.8	1.4	4.1	2.7	1.35
C	5.8	3.2	2.9	6.9	2.7	2.0
E	7.3	4.3	4.1	8.2	2.9	2.05
F	7.3	5.8	4.1	8.2	4.0	2.05

GUIDE TO APPLICATION

- AC Ripple Current:** the maximum allowable ripple current shall be determined from the formula:

$$I_{RMS} = \sqrt{\frac{P}{R_{ESR}}}$$

where,

P = power dissipation in W at +25 °C as given in the tables in the product datasheets.

R_{ESR} = the capacitor equivalent series resistance at the specified frequency.

- AC Ripple Voltage:** the maximum allowable ripple voltage shall be determined from the formula:

$$V_{RMS} = Z \sqrt{\frac{P}{R_{ESR}}}$$

or, from the formula:

$$V_{RMS} = I_{RMS} \times Z$$

where,

P = power dissipation in W at +25 °C as given in the tables in the product datasheets.

R_{ESR} = The capacitor equivalent series resistance at the specified frequency.

Z = The capacitor impedance at the specified frequency.

- The tantalum capacitors must be used in such a condition that the sum of the working voltage and ripple voltage peak values does not exceed the rated voltage as shown in figure below.

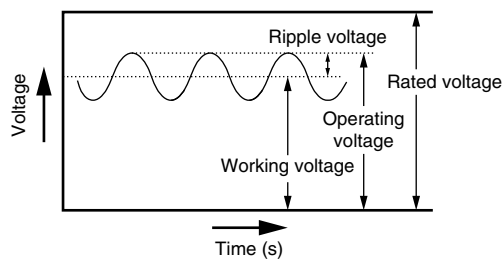

- Temperature Derating:** power dissipation is affected by the heat sinking capability of the mounting surface. If these capacitors are to be operated at temperatures above +25 °C, the permissible ripple current (or voltage) shall be calculated using the derating coefficient as shown in the table below:

MAXIMUM RIPPLE CURRENT TEMPERATURE DERATING FACTOR	
TEMPERATURE	TMC
≤ 25 °C	1.0
85 °C	0.9
105 °C	0.65
125 °C	0.4

- Reverse Voltage:** the capacitors are not intended for use with reverse voltage applied. If the application of a reverse voltage is unavoidable, it must not exceed the following values:

At 25 °C: 10 % of the rated voltage or 1 V, whichever is smaller.

At 85 °C: 5 % of the rated voltage or 0.5 V, whichever is smaller.

- Mounting Precautions:**

- Limit Pressure on Capacitor Installation with Mounter:** pressure must not exceed 4.9 N with a tool end diameter of 1.5 mm when applied to the capacitors using an absorber, centering tweezers, or similar (maximum permitted pressurization time: 5 s). An excessively low absorber setting position would result in not only the application of undue force to the capacitors but capacitor and other component scattering, circuit board wiring breakage, and / or cracking as well, particularly when the capacitors are mounted together with other chips having a height of 1 mm or less.

- Flux Selection**

- 5.2.1 Select a flux that contains a minimum of chlorine and amine.

- 5.2.2 After flux use, the chlorine and amine in the flux remain must be removed.

- Cleaning After Mounting:** the following solvents are usable when cleaning the capacitors after mounting. Never use a highly active solvent.

- Halogen organic solvent (HCFC225, etc.)
- Alcoholic solvent (IPA, ethanol, etc.)
- Petroleum solvent, alkali saponifying agent, water, etc.

Circuit board cleaning must be conducted at a temperature of not higher than 50 °C and for an immersion time of not longer than 30 minutes. When an ultrasonic cleaning method is used, cleaning must be conducted at a frequency of 48 kHz or lower, at a vibrator output of 0.02 W/cm³, at a temperature of not higher than 40 °C, and for a time of 5 minutes or shorter.

Notes

- Care must be exercised in cleaning process so that the mounted capacitor will not come into contact with any cleaned object or the like or will not get rubbed by a stiff brush or similar. If such precautions are not taken particularly when the ultrasonic cleaning method is employed, terminal breakage may occur
- When performing ultrasonic cleaning under conditions other than stated above, conduct adequate advance checkout



Disclaimer

ALL PRODUCT, PRODUCT SPECIFICATIONS AND DATA ARE SUBJECT TO CHANGE WITHOUT NOTICE TO IMPROVE RELIABILITY, FUNCTION OR DESIGN OR OTHERWISE.

Vishay Intertechnology, Inc., its affiliates, agents, and employees, and all persons acting on its or their behalf (collectively, "Vishay"), disclaim any and all liability for any errors, inaccuracies or incompleteness contained in any datasheet or in any other disclosure relating to any product.

Vishay makes no warranty, representation or guarantee regarding the suitability of the products for any particular purpose or the continuing production of any product. To the maximum extent permitted by applicable law, Vishay disclaims (i) any and all liability arising out of the application or use of any product, (ii) any and all liability, including without limitation special, consequential or incidental damages, and (iii) any and all implied warranties, including warranties of fitness for particular purpose, non-infringement and merchantability.

Statements regarding the suitability of products for certain types of applications are based on Vishay's knowledge of typical requirements that are often placed on Vishay products in generic applications. Such statements are not binding statements about the suitability of products for a particular application. It is the customer's responsibility to validate that a particular product with the properties described in the product specification is suitable for use in a particular application. Parameters provided in datasheets and / or specifications may vary in different applications and performance may vary over time. All operating parameters, including typical parameters, must be validated for each customer application by the customer's technical experts. Product specifications do not expand or otherwise modify Vishay's terms and conditions of purchase, including but not limited to the warranty expressed therein.

Hyperlinks included in this datasheet may direct users to third-party websites. These links are provided as a convenience and for informational purposes only. Inclusion of these hyperlinks does not constitute an endorsement or an approval by Vishay of any of the products, services or opinions of the corporation, organization or individual associated with the third-party website. Vishay disclaims any and all liability and bears no responsibility for the accuracy, legality or content of the third-party website or for that of subsequent links.

Vishay products are not designed for use in life-saving or life-sustaining applications or any application in which the failure of the Vishay product could result in personal injury or death unless specifically qualified in writing by Vishay. Customers using or selling Vishay products not expressly indicated for use in such applications do so at their own risk. Please contact authorized Vishay personnel to obtain written terms and conditions regarding products designed for such applications.

No license, express or implied, by estoppel or otherwise, to any intellectual property rights is granted by this document or by any conduct of Vishay. Product names and markings noted herein may be trademarks of their respective owners.