

SKM75GB12T4



SEMITRANS®2

Fast IGBT4 Modules

SKM75GB12T4

Features

- $V_{CE(sat)}$ with positive temperature coefficient
- High short circuit capability, self limiting to 6 x I_{Cnom}
- Fast & soft inverse CAL diodes
- Large clearance (10 mm) and creepage distances (20 mm)
- Isolated copper baseplate using DBC Technology (Direct Copper Bonding)

Typical Applications

- AC inverter drives
- UPS
- Electronic welders at fsw up to 20 kHz

Remarks

- Case temperature limited to $T_c = 125^\circ\text{C}$ max, recomm.
 $T_{op} = -40 \dots +150^\circ\text{C}$, product rel. results valid for $T_j = 150^\circ$

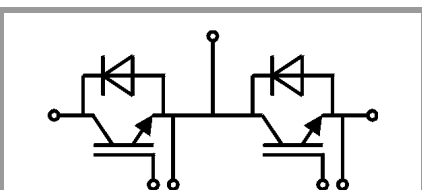

GB

Absolute Maximum Ratings				
Symbol	Conditions	Values	Unit	
IGBT				
V_{CES}		1200	V	
I_C	$T_j = 175^\circ\text{C}$	$T_c = 25^\circ\text{C}$	115	A
		$T_c = 80^\circ\text{C}$	88	A
I_{Cnom}		75	A	
I_{CRM}	$I_{CRM} = 3 \times I_{Cnom}$	225	A	
V_{GES}		-20 ... 20	V	
t_{psc}	$V_{CC} = 800\text{ V}$	$T_j = 150^\circ\text{C}$	10	μs
	$V_{GE} \leq 15\text{ V}$			
	$V_{CES} \leq 1200\text{ V}$			
T_j		-40 ... 175	$^\circ\text{C}$	
Inverse diode				
I_F	$T_j = 175^\circ\text{C}$	$T_c = 25^\circ\text{C}$	97	A
		$T_c = 80^\circ\text{C}$	73	A
I_{Fnom}		75	A	
I_{FRM}	$I_{FRM} = 3 \times I_{Fnom}$	225	A	
I_{FSM}	$t_p = 10\text{ ms}$, $\sin 180^\circ$, $T_j = 25^\circ\text{C}$	430	A	
T_j		-40 ... 175	$^\circ\text{C}$	
Module				
$I_{t(RMS)}$		200	A	
T_{stg}		-40 ... 125	$^\circ\text{C}$	
V_{isol}	AC sinus 50Hz, $t = 1\text{ min}$	4000	V	

Characteristics					
Symbol	Conditions	min.	typ.	max.	Unit
IGBT					
$V_{CE(sat)}$	$I_C = 75\text{ A}$ $V_{GE} = 15\text{ V}$ chipelevel	$T_j = 25^\circ\text{C}$	1.85	2.1	V
		$T_j = 150^\circ\text{C}$	2.25	2.45	V
V_{CE0}		$T_j = 25^\circ\text{C}$	0.8	0.9	V
		$T_j = 150^\circ\text{C}$	0.7	0.8	V
r_{CE}	$V_{GE} = 15\text{ V}$	$T_j = 25^\circ\text{C}$	14.0	16.0	$\text{m}\Omega$
		$T_j = 150^\circ\text{C}$	20.7	22.0	$\text{m}\Omega$
$V_{GE(th)}$	$V_{GE} = V_{CE}$, $I_C = 3\text{ mA}$	5	5.8	6.5	V
I_{CES}	$V_{GE} = 0\text{ V}$ $V_{CE} = 1200\text{ V}$	$T_j = 25^\circ\text{C}$	0.1	0.3	mA
		$T_j = 150^\circ\text{C}$			mA
C_{ies}	$V_{CE} = 25\text{ V}$ $V_{GE} = 0\text{ V}$	$f = 1\text{ MHz}$	4.4		nF
C_{oes}		$f = 1\text{ MHz}$	0.29		nF
C_{res}		$f = 1\text{ MHz}$	0.235		nF
Q_G	$V_{GE} = -8\text{ V} \dots +15\text{ V}$		425		nC
R_{Gint}	$T_j = 25^\circ\text{C}$		10.0		Ω
$t_{d(on)}$	$V_{CC} = 600\text{ V}$	$T_j = 150^\circ\text{C}$	150		ns
t_r	$I_C = 75\text{ A}$ $V_{GE} = \pm 15\text{ V}$	$T_j = 150^\circ\text{C}$	39		ns
		$T_j = 150^\circ\text{C}$	11		mJ
E_{on}	$R_{Gon} = 1\ \Omega$	$T_j = 150^\circ\text{C}$			mJ
$t_{d(off)}$	$R_{Goff} = 1\ \Omega$	$T_j = 150^\circ\text{C}$	370		ns
t_f	$di/dt_{on} = 1600\text{ A}/\mu\text{s}$	$T_j = 150^\circ\text{C}$	66		ns
E_{off}	$di/dt_{off} = 950\text{ A}/\mu\text{s}$	$T_j = 150^\circ\text{C}$	6.9		mJ
$R_{th(j-c)}$	per IGBT			0.38	K/W



SEMITRANS®2

Fast IGBT4 Modules

SKM75GB12T4

Features

- $V_{CE(sat)}$ with positive temperature coefficient
- High short circuit capability, self limiting to $6 \times I_{cnom}$
- Fast & soft inverse CAL diodes
- Large clearance (10 mm) and creepage distances (20 mm)
- Isolated copper baseplate using DBC Technology (Direct Copper Bonding)

Typical Applications

- AC inverter drives
- UPS
- Electronic welders at fsw up to 20 kHz

Remarks

- Case temperature limited to $T_c = 125^\circ\text{C}$ max, recomm.
 $T_{op} = -40 \dots +150^\circ\text{C}$, product rel. results valid for $T_j = 150^\circ$

Characteristics						
Symbol	Conditions		min.	typ.	max.	Unit
Inverse diode						
$V_F = V_{EC}$	$I_F = 75 \text{ A}$ $V_{GE} = 0 \text{ V}$ chip	$T_j = 25^\circ\text{C}$		2.17	2.49	V
		$T_j = 150^\circ\text{C}$		2.11	2.42	V
V_{F0}		$T_j = 25^\circ\text{C}$		1.3	1.5	V
		$T_j = 150^\circ\text{C}$		0.9	1.1	V
r_F		$T_j = 25^\circ\text{C}$		11.6	13.2	m Ω
		$T_j = 150^\circ\text{C}$		16.1	17.6	m Ω
I_{RRM}	$I_F = 75 \text{ A}$	$T_j = 150^\circ\text{C}$		37		A
Q_{rr}	$di/dt_{off} = 990 \text{ A}/\mu\text{s}$	$T_j = 150^\circ\text{C}$		12.6		μC
E_{rr}	$V_{GE} = \pm 15 \text{ V}$ $V_{CC} = 600 \text{ V}$	$T_j = 150^\circ\text{C}$		4.7		mJ
$R_{th(j-c)}$	per diode				0.58	K/W
Module						
L_{CE}					30	nH
$R_{CC'+EE'}$	terminal-chip	$T_c = 25^\circ\text{C}$		0.65		m Ω
		$T_c = 125^\circ\text{C}$		1		m Ω
$R_{th(c-s)}$	per module			0.04	0.05	K/W
M_s	to heat sink M6		3		5	Nm
M_t		to terminals M5	2.5		5	Nm
						Nm
w					160	g

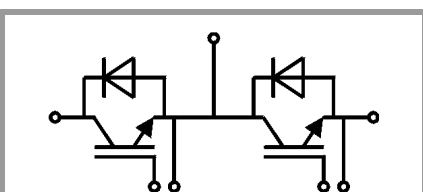

GB

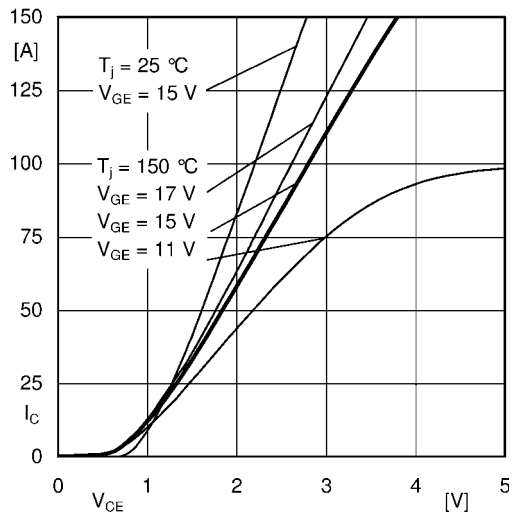

Fig. 1: Typ. output characteristic, inclusive $R_{CC'+EE'}$

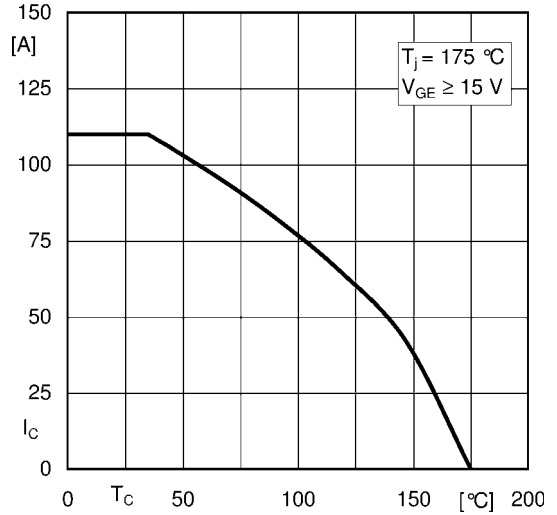

Fig. 2: Rated current vs. temperature $I_C = f(T_C)$

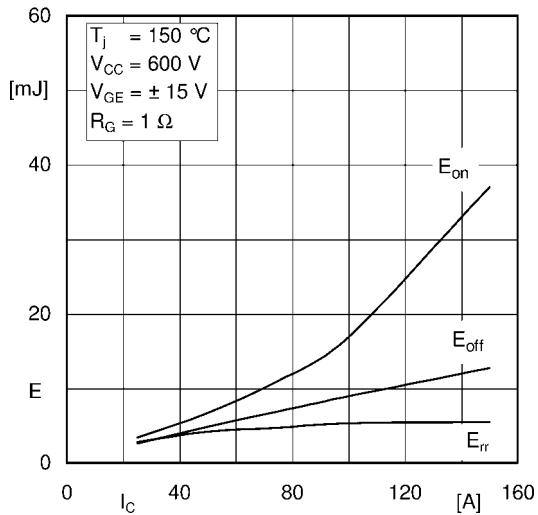

Fig. 3: Typ. turn-on /-off energy = $f(I_C)$

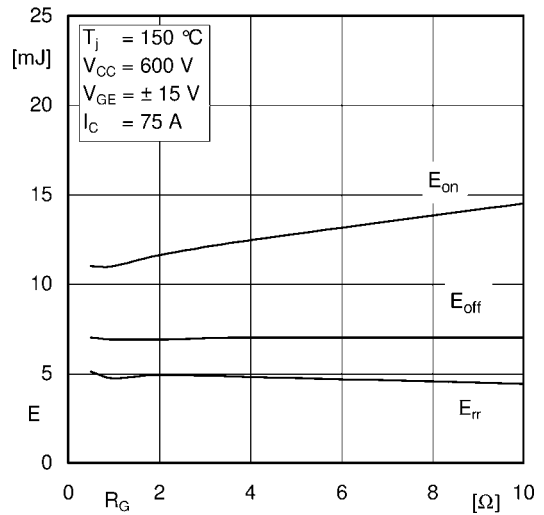

Fig. 4: Typ. turn-on /-off energy = $f(R_G)$

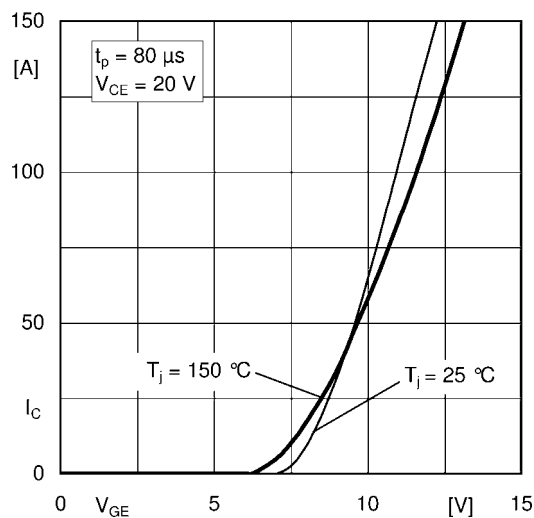

Fig. 5: Typ. transfer characteristic

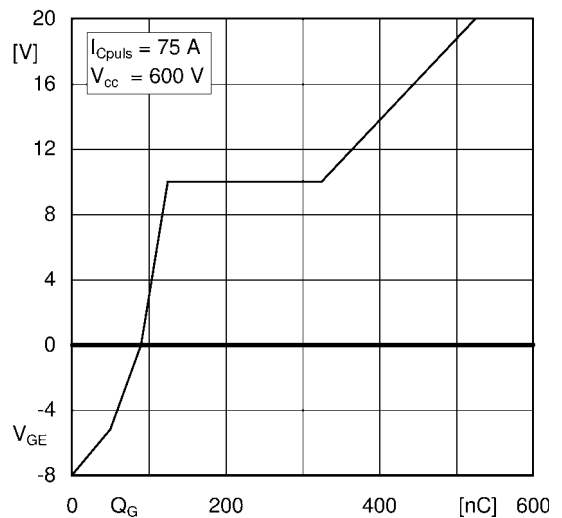

Fig. 6: Typ. gate charge characteristic

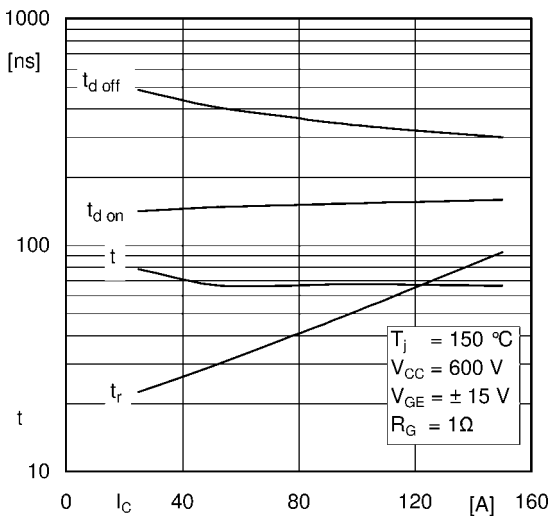

Fig. 7: Typ. switching times vs. I_C

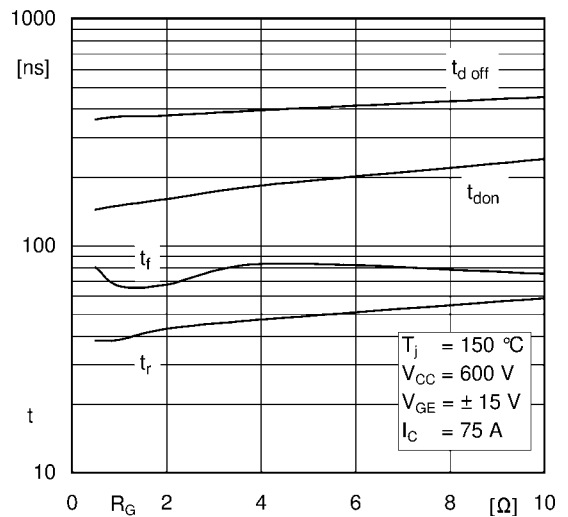

Fig. 8: Typ. switching times vs. gate resistor R_G

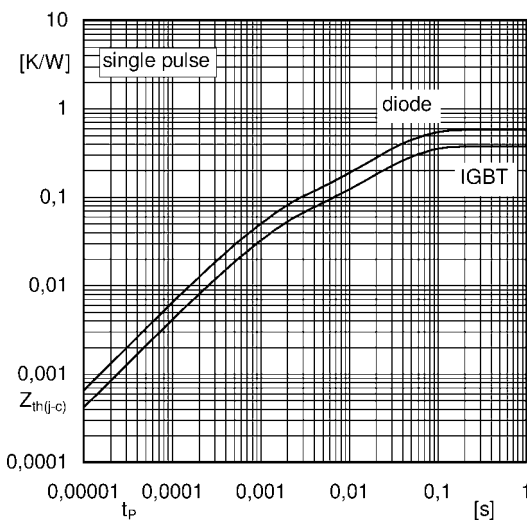

Fig. 9: Transient thermal impedance

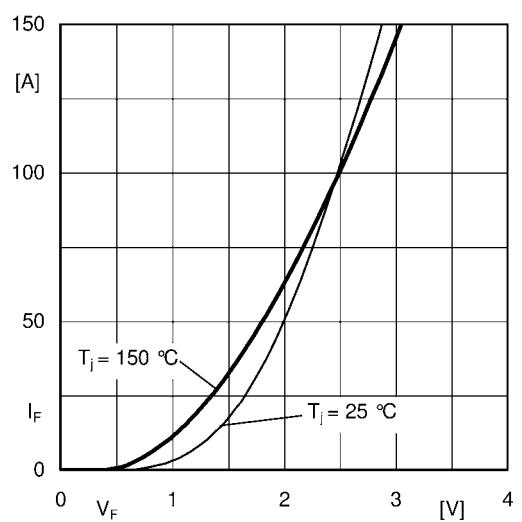

Fig. 10: CAL diode forward characteristic

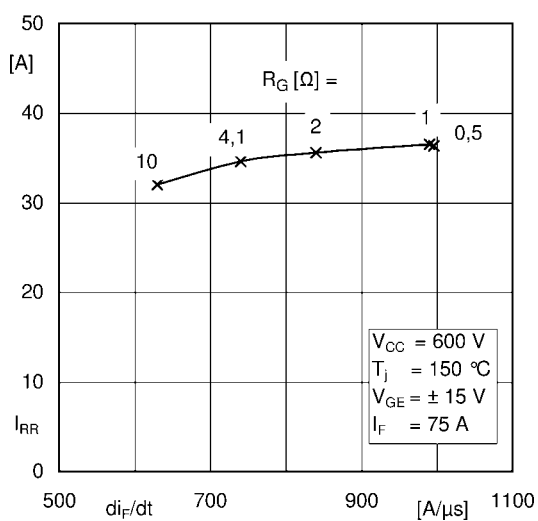

Fig. 11: CAL diode peak reverse recovery current

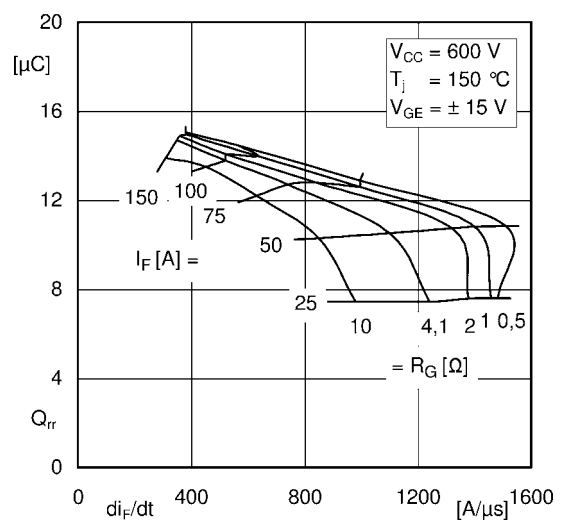
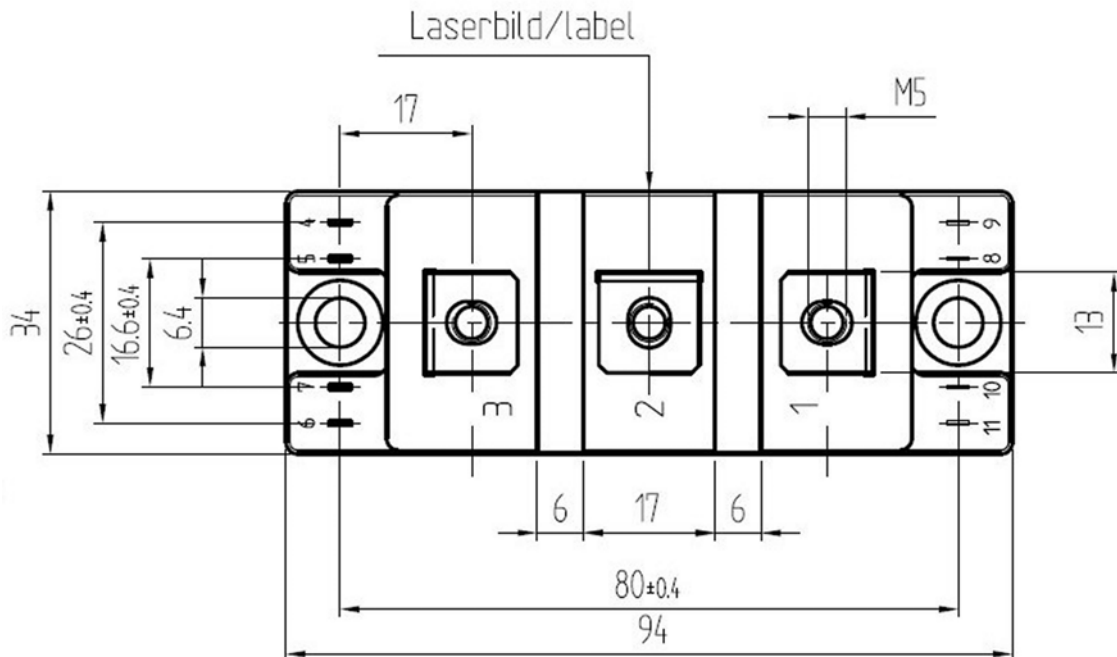
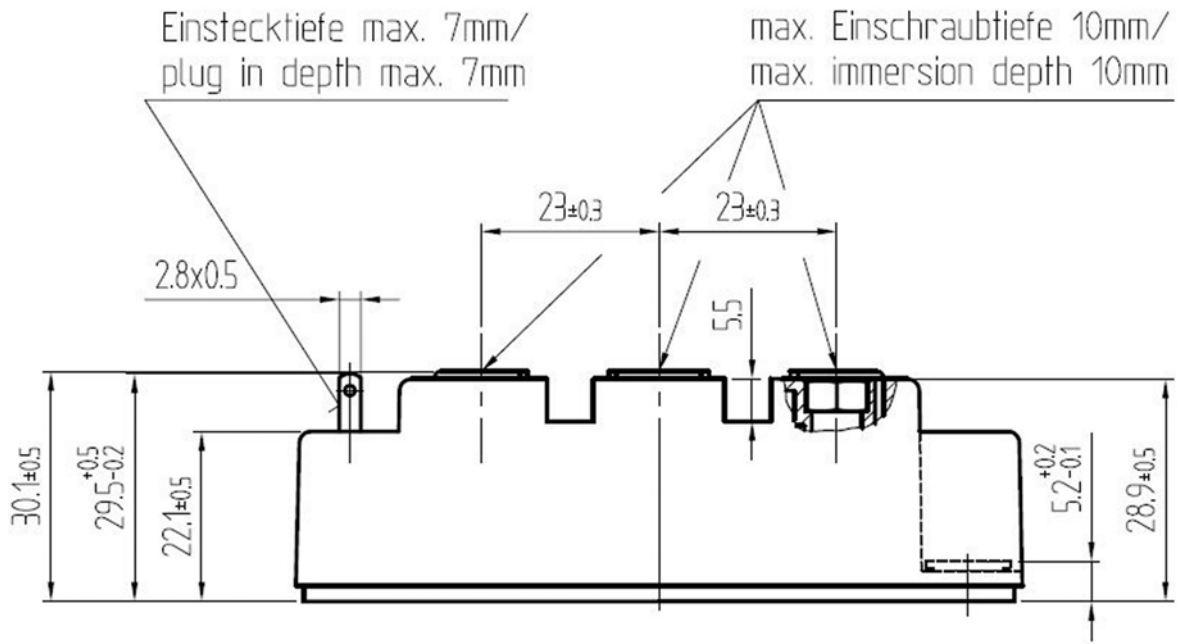
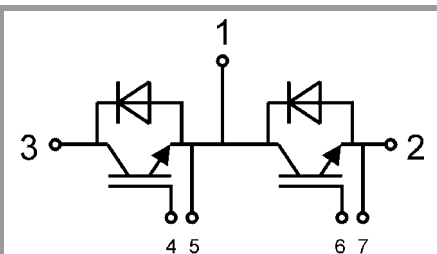

Fig. 12: Typ. CAL diode peak reverse recovery charge

SKM75GB12T4



Semitrans 2



GB

This is an electrostatic discharge sensitive device (ESDS), international standard IEC 60747-1, Chapter IX.

This technical information specifies semiconductor devices but promises no characteristics. No warranty or guarantee expressed or implied is made regarding delivery, performance or suitability.