

# "18650" LITHIUM-ION BATTERY HOLDERS



## Leaf Springs



1043\*

## Leaf Spring Polarized



1043P\*

## Leaf Spring Solder Lugs



1044\*

## Coil Spring Polarized

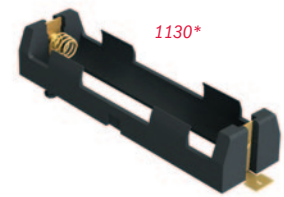

1130\*

### FEATURES

- Low profile surface mount holder for Cylindrical Lithium and alkaline batteries
- UL 94V-0 heat resistant nylon housing well suited for reflow soldering
- Battery installation and removal does not require tools
- Securely holds battery in place

- Accommodates cells with or without built-in PCB protection circuits
- Polarity clearly marked for orientation
- Polarized holders available for protection against improper battery installation

\*Dual Cell Not Shown

### SPECIFICATIONS

- Operating Temp Range:** -60°F to +293°F (-50°C to +145°C)
- Base:** High Temp Nylon 46, UL 94V-0
- Contacts:** Stainless Steel/Music Wire  
SMT - Gold Plate (Flash)  
THM - Tin-Nickel Plate



PC Battery Clip Available See Page 13.

## THRU HOLE MOUNT

## SURFACE MOUNT

### SINGLE CELL

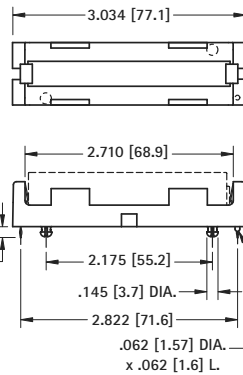
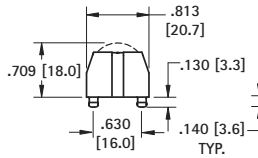
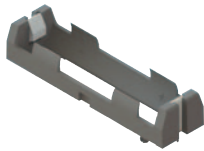

### Mounting Detail

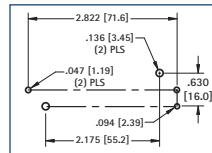

### SPECIFICATIONS

- Base:** PBT, UL 94V-0, Grey
- Contacts:** .012 (.30) Stainless Steel, Tin-Nickel Plate

**CAT. NO. 1043** Leaf Springs

**CAT. NO. 1043P** Leaf Spring Polarized

**CAT. NO. 1131** Coil Spring Polarized

**CAT. NO. 1044** Solder Lugs

**Packaging Spec's:** 50 pieces per tray

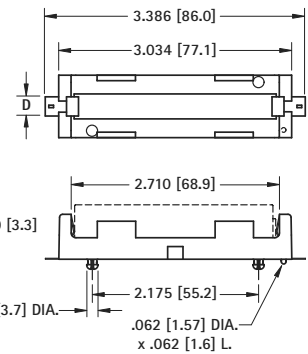
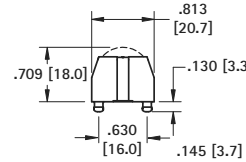

### Pad Layout

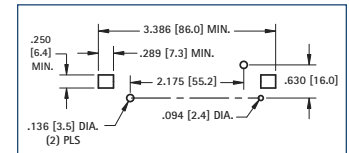

### SPECIFICATIONS

- Base:** High Temp Nylon 46, UL 94V-0
- Contacts:** .012 (.30) Stainless Steel, Gold Plate (Flash)

**CAT. NO. 1042** Leaf Springs

**CAT. NO. 1042P** Leaf Spring Polarized

**CAT. NO. 1130** Coil Spring Polarized

**Packaging Spec's:** 50 pieces per tray

### DUAL CELL

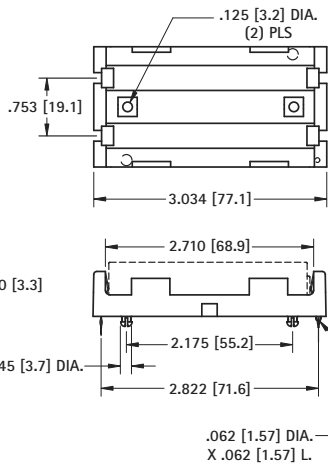
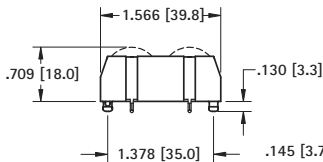
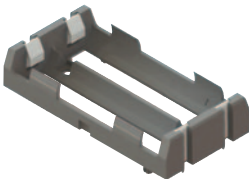

### Mounting Detail

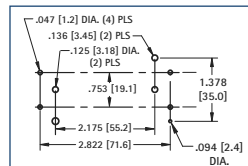

### SPECIFICATIONS

- Base:** PBT, UL 94V-0, Grey
- Contacts:** .012 (.30) Stainless Steel, Tin-Nickel Plate

**CAT. NO. 1049** Dual Springs

**CAT. NO. 1049P** Leaf Spring Polarized

**CAT. NO. 1135** Coil Spring Polarized

**CAT. NO. 1047** Solder Lugs

**Packaging Spec's:** 25 pieces per tray

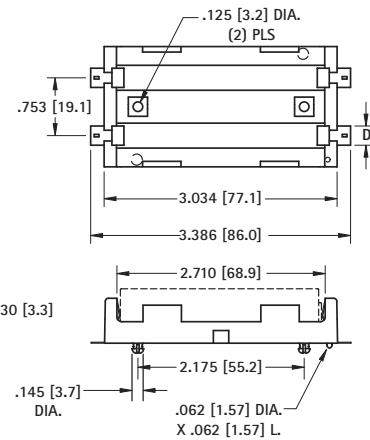
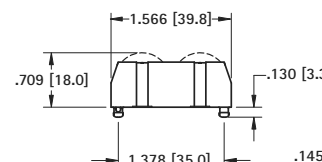

### Pad Layout

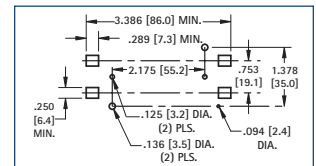

### SPECIFICATIONS

- Base:** High Temp Nylon 46, UL 94V-0
- Contacts:** .012 (.30) Stainless Steel, Gold Plate (Flash)

**CAT. NO. 1048** Dual Springs

**CAT. NO. 1048P** Leaf Spring Polarized

**CAT. NO. 1134** Coil Spring Polarized

**Packaging Spec's:** 25 pieces per tray